

## Preparation Before Installation

1. This shower system needs to be installed to the wall, please make sure check all the size according to the instruction before installation
2. Clean the impurity and sludge in the hose before assembling to avoid leaking
3. Proper water pressure should be between 0.1Mpa-1.0Mpa
4. Turn off the water supply before installation

### Installation Manual Tools You Will Need:

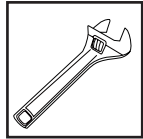

adjustable wrench



wrench hexagon

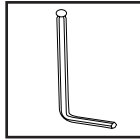

Phillips screwdriver

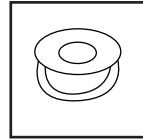

pipe tape

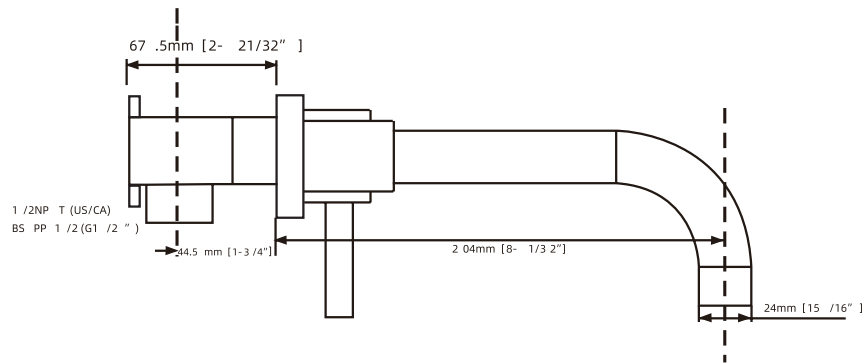
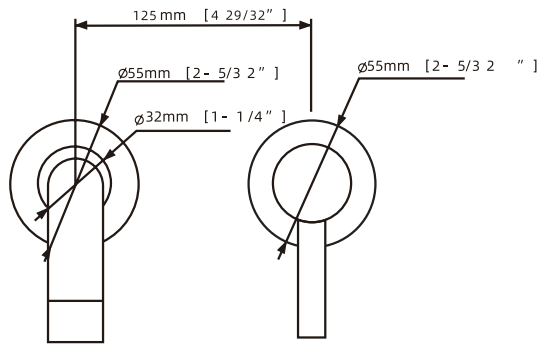

## Installation Instructions

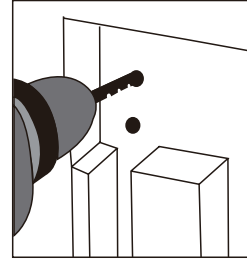

1. Confirm the location of the concealed faucet body, then drill two holes on the wall with percussion drill

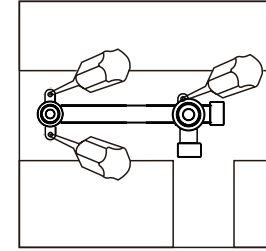

2. Install the concealed faucet body

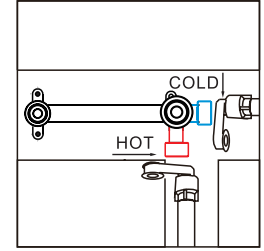

3. Connect hot and cold water inlet pipes

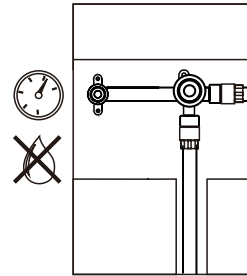

4. Each pipes shall be pressure tested to ensure no leakage

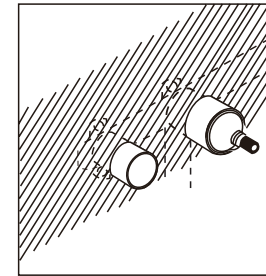

5. Waiting the wall to be tiled

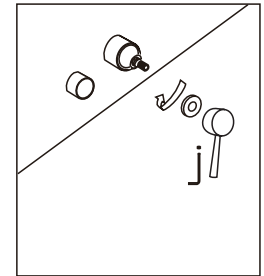

6. Install the handles as the picture shows

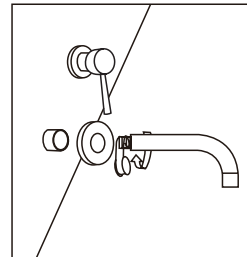

7. Install the outlet pipe well

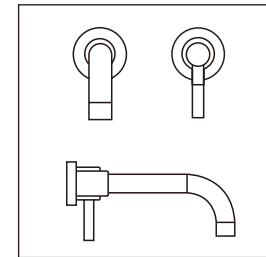

8. Finished